

# The crane technology

10.2019

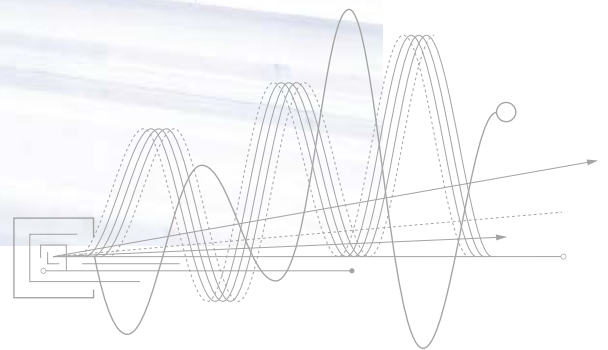

*Partner of Experts*

**STAHL**  
CraneSystems



# The crane technology

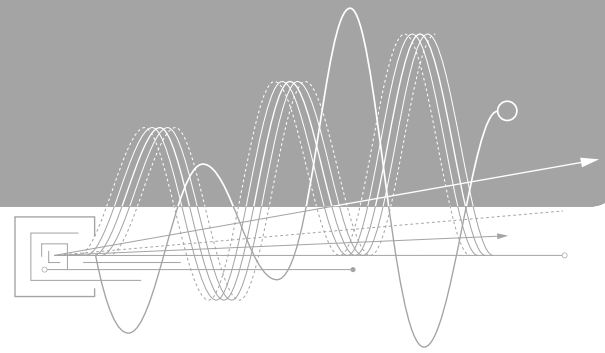

The hoisting and crane technology from STAHL Crane-Systems ranks among the most distinctive and comprehensive on offer worldwide. The high-quality components are among the best available anywhere from a technical point of view. Users, crane manufacturers and system builders value these economical components and complete solutions that prove their worth in use day after day.

Thanks to our sound know-how and decades of experience, we are able to offer sophisticated products, from chain and wire rope hoists to crane endcarriages, travel drives and wheel blocks as well as crane electrics from easy-to-use control pendants to complex control systems. On top of this, there is our extensive portfolio of hoisting equipment. Our customers can rely on all components working together efficiently like fine clockwork. Our hoisting and crane technology stands out for offering the right solution for every field. And for completely unusual requirements, our experts from the engineering department devise special custom solutions. Modern production procedures and certified processes guarantee consistent high quality.

Even in potentially explosive work areas, you do not need to forego hoisting and crane technology from STAHL CraneSystems. If wanted, the complete programme but for a few exceptions is available in explosion-proof design for Zone 1, Zone 2, Zone 21 and Zone 22. It is not for nothing that we are one of the market leaders in explosion-proof hoisting technology and crane components.

## The facts

---

- One of the most comprehensive hoisting and crane technology programmes worldwide
- Modular design of the hoisting and crane technology systems
- Reliable, low-maintenance, service-friendly components
- Custom solutions through engineering
- Own production in Germany
- Optionally available in explosion-proof design according to ATEX or IECEx

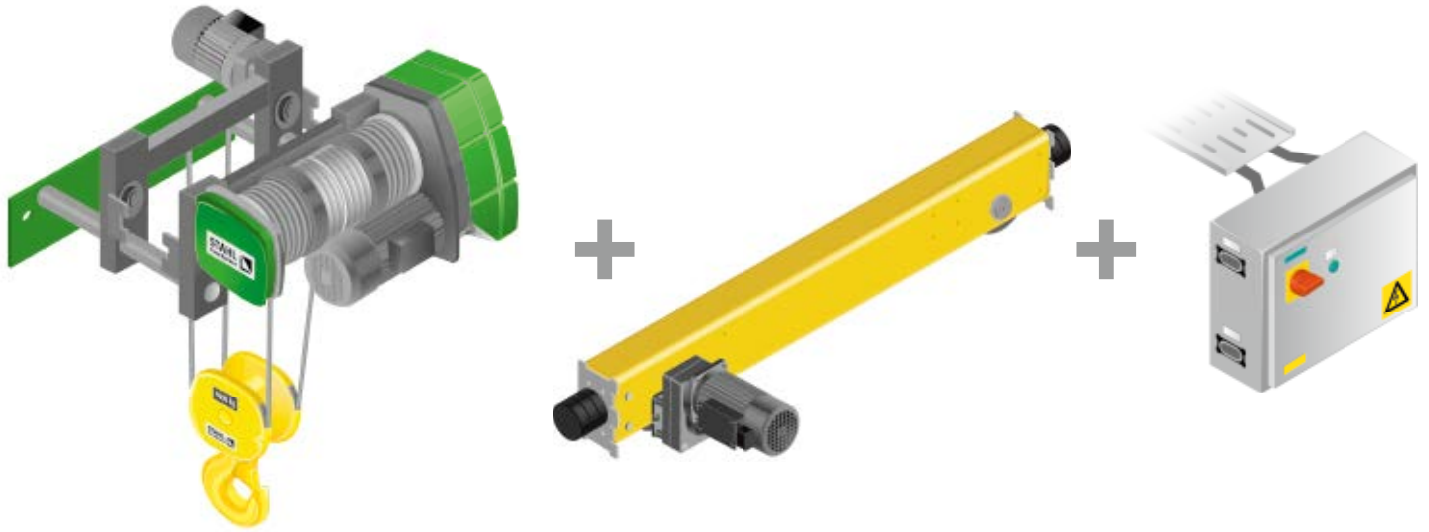

# The product portfolio

## The wire rope hoist and winch programmes

Behind the attractive design of STAHL CraneSystems' wire rope hoists lies a compact, robust and largely low-maintenance construction. They are reliable, powerful and long-lived.

The wire rope hoists and winches are manufactured in systematic modular design and dimensioned for a safe working load range from 500 kg to 160,000 kg. We offer our versatile SH series in five frame sizes with 26 S.W.L. variants for the safe working load range from 500 kg to 25,000 kg. The upper safe working load range to 125,000 kg is covered by the field-proven AS model. The SHW 8 winch programme extends the range of application into the high-load bracket to 160,000 kg. Off-standard applications and customised solutions can be achieved cost-effectively thanks to the modular design of the standard components of all wire rope hoists and winches.

The SH and AS wire rope hoist programmes and the SHW winch programme are also available in explosion-proof design complying with ATEX or IECEx.

→ In our engineering department engineers and technicians develop individual custom and off-standard solutions tailored to your specific requirements from one of the largest portfolios of standard components available. They naturally conform to the latest national and international directives and laws.

→ You can find more information in our brochures "The SH wire rope hoist", "The AS7 wire rope hoist", "The ASR7 wire rope hoist" and "The SHW 8 winch", which we will gladly send to you by post.





- Standard
- Option

| Type    | S.W.L to [kg] | Stationary | OE double rail crab | Monorail trolleys |    |     |
|---------|---------------|------------|---------------------|-------------------|----|-----|
|         |               |            |                     | KE                | UE | DKE |
| SH 3    | 3,200         | ■          | ■                   | ■                 | ■  | ■   |
| SH 4    | 6,300         | ■          | ■                   | ■                 | ■  | ■   |
| SH 5    | 10,000        | ■          | ■                   | ■                 | ■  | ■   |
|         | 12,500        | ■          | ■                   | ■                 | ■  | □   |
| SHR 6   | 16,000        | ■          | ■                   | ■                 | ■  | □   |
| SH 6    | 25,000        | ■          | ■                   | □                 | ■  | □   |
| ASR 7   | 32,000        | ■          | ■                   | □                 | □  | □   |
| AS 7    | 80,000        | ■          | ■                   | □                 | □  | □   |
| AS 7 ZW | 125,000       | ■          | ■                   | □                 | □  | □   |
| SHW 8   | 160,000       | ■          | ■                   | □                 | □  | □   |

### The chain hoist programme

The chain hoist programme ranks among the most distinctive and comprehensive on offer worldwide and has been used thousands of times for decades. It is robust and reliable and requires little maintenance. The innovative and pioneering design of the chain hoist offers considerable economic advantages and is especially suitable for rugged use in heavy industry.

With 13 S.W.L. ranges from 125 kg to 6,300 kg, three construction types and various suspensions, the ST model series permits countless possible combinations. Time and again they result in new, practical off-standard designs, such as the dual chain hoist with fixed or variable spacing between hooks.

This program is available in the S.W.L. range from 250 kg to 5,000 kg in explosion-proof design for Zone 1, Zone 21 and Zone 22 according to ATEX and IECEx.

→ In our engineering department engineers and technicians develop individual custom and off-standard solutions tailored to your specific requirements from one of the largest portfolios of standard components available. They naturally conform to the latest national and international directives and laws.

→ You can find more information in our brochure "The ST chain hoist", which we will gladly send to you by post.

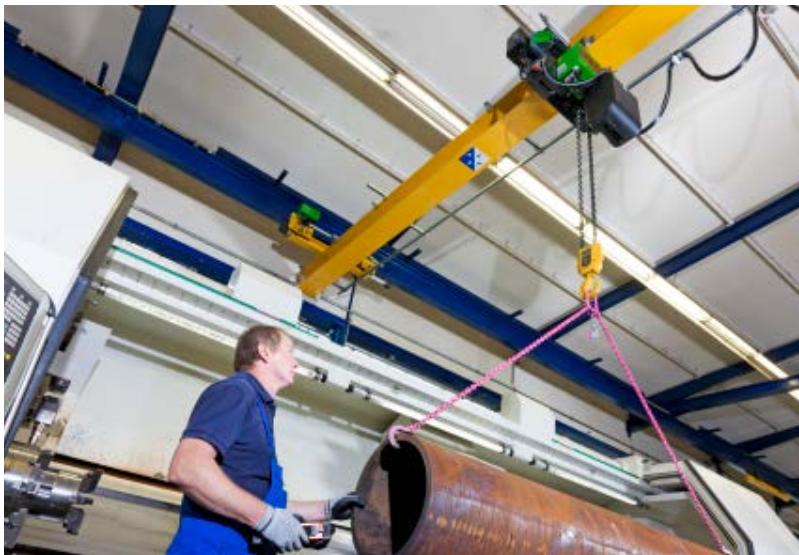



■ Standard □ Option

| Typ   | Load capacity up to [kg] | Stationary | Push trolley | Electric trolley | Articulated trolley | Short headroom trolley | Extra short headroom trolley | Dual chain hoist | Big Bag |
|-------|--------------------------|------------|--------------|------------------|---------------------|------------------------|------------------------------|------------------|---------|
| ST 05 | 125 – 630                | ■          | ■            | ■                | ■                   | ■                      | ■                            | ■                | –       |
| ST 10 | 500 – 1,000              | ■          | ■            | ■                | ■                   | ■                      | –                            | ■                | ■       |
| ST 20 | 1,000 – 2,000            | ■          | ■            | ■                | ■                   | ■                      | –                            | –                | –       |
| ST 30 | 1,250 – 3,200            | ■          | ■            | ■                | ■                   | ■                      | ■                            | ■                | ■       |
| ST 32 | 1,250 – 3,200            | ■          | ■            | ■                | ■                   | ■                      | –                            | –                | –       |
| ST 50 | 2,500 – 5,000            | ■          | ■*           | ■                | ■                   | ■                      | ■                            | ■                | ■       |
| ST 60 | 3,200 – 6,300            | ■          | ■*           | ■                | ■                   | ■                      | □                            | ■                | –       |

\* Only available with 1/1 reeving in the standard range.

## The electrical components

There are standard contactor controls available for all common control voltages. In their basic version, the components are supplied with plug connections as far as this is technically possible and meets requirements. The standard equipment can, however, be supplemented effectively with options to suit your specific application. You can choose between different control and monitoring components as well as optional frequency inverters for hoists and travel drives. This equipment will increase safety in material handling and lengthen the service life of your system.

### Cable power supply systems



- Delivery complete with galvanised C-rail, mounting hardware, cantilever arms for clamping, cable trolley, cables and terminal box

### Plastic bus bar



- Delivery complete in straight sections, including mounting and connection hardware, current collector trolley

### Radio remote control units



- Pushbutton units with belt clip, optionally with signal feedback from the crane
- Robust plastic housing
- IP 65 protection
- Other radio remote control units on request

### Controls



- KSG distributed control: lifting and cross travel on the crab, long travel at the crane bridge
- KSK complete control: all electrical devices in a panel box, for universal use
- 2 speeds
- IP 55 protection
- Temperature range  $-20^{\circ}\text{C}$  to  $+40^{\circ}\text{C}$

### Frequency inverter for ›Drive‹



- Extension of the system service life through stepless acceleration and deceleration
- Reduced load swing through soft starting and braking, fast and precise positioning of the load

### Control pendant



- Robust control pendant with EMERGENCY STOP pushbutton and control cable
- All switching elements for hoist, travel carriage and crane are 2-step
- IP 65 protection
- Additional buttons, for example to activate a horn, can be integrated
- Optional load display. All data shown can be read out on a notebook with the help of the SMC multicontroller.



## The crane endcarriages and travel drives

The robust crane endcarriages from STAHL CraneSystems are manufactured in modern series production. They are easy to mount on both suspension cranes (underslung cranes) and bridge cranes. The wheels, made of high-quality spheroidal graphite cast iron with self-lubrication, come in various diameters. The buffer stops are delivered as standard. Movement for your crane. The frequency-controlled travel drives enable quick and precise positioning of the load without swinging. The low-noise gears ensure smooth starting, steady acceleration and soft braking, thereby ensuring high operational reliability and long service life.

### Endcarriages for bridge cranes



- 9 different wheel diameters from 90 mm to 500 mm
- Spans up to 40 m
- Safe working loads from 125 kg to 160,000 kg
- Higher safe working loads on request

### Endcarriages for suspension cranes



- 4 different wheel diameters from 80 mm to 200 mm
- Spans up to 28 m
- Safe working loads from 125 kg to 16,000 kg

### Load display



- 4-digit, 7-segment SLD load display (Stahl Load Display), large-format, luminescent red digits, available with various interfaces including CAN
- Height of digits selectable between 60 mm, 100 mm and 150 mm
- No additional sensor required as standard load sensor is used

### Wheel block



- 6 different sizes for wheel loads from 5,000 kg to 30,000 kg
- 3 standard configurations for connection to customer structures
- Low-maintenance direct drive with two speeds
- Maintenance-free anti-friction bearing

### Travel drives



- Low-maintenance crane travel drive
- In standard version with two speeds in a ratio of 1:4 or with stepless frequency control in a ratio of 1:10
- Integrated disc brake

# Expertise in explosion protection



STAHL CraneSystems is known internationally as an explosion protection specialist and is a world market leader in explosion-proof crane technology. The safety of people and machines in areas subject to gas and dust explosion hazards is our top priority. Here we make no compromises. As developer of numerous innovations in this field, we have influenced the progress in crane technology perceptibly. Experience and know-how from many decades, our own fundamental research and development, approvals from the German national metrology institute PTB and other test institutes in many countries underline our expertise.

Explosion-proof hoisting and crane technology from STAHL CraneSystems ranks among the safest technology on the market in the chemical, petrochemical and pharmaceutical industries, the food processing industry as well as the power supply, shipbuilding, offshore and natural gas liquefaction industries (LNG).

The explosion-proof hoist and crane components and their supplementary equipment are based without exception on our standard programmes. All components – from motor and brake to controls and control pendant – come from our own production with certified quality assurance systems. This ensures the complete, high-quality explosion protection on which users, crane manufacturers and system builders around the world have relied for decades.

The strict ATEX directives and IECEx regulations for mechanical and electrical explosion protection are naturally fulfilled.

## The facts

---

- International specialist for explosion-proof hoisting and crane technology
  - One of the most extensive product portfolios for Zone 1, Zone 2, Zone 21 and Zone 22 worldwide
  - All hoisting and crane technology as well as additional equipment available in explosion-proof design
  - Design to ATEX or IECEx in certified quality
- ➔ You can find more information in our brochures “Expertise in explosion protection” and “The LNG engineering solution”, which we will gladly send to you by post.



| Use            | Category  | Protection against | Explosion protection class                         |
|----------------|-----------|--------------------|--|
| <b>Zone 1</b>  | Ex II 2 G | Gas                | Ex de IIB T4 Gb or Ex de IIC T4 Gb                 |
| <b>Zone 2*</b> | Ex II 3 G | Gas                | Ex de nA IIB T3 (T4) Gc or Ex de nA IIC T3 (T4) Gc |
| <b>Zone 21</b> | Ex II 2 D | Dust               | Ex tb IIIC T 120 °C Db                             |
| <b>Zone 22</b> | Ex II 3 D | Dust               | Ex tc IIIC T 120 °C Dc                             |

\* Versions for Zone 2 are only available as standard in the wire rope hoist programme.

# The CraneKit

With its CraneKits for suspension, single girder and double girder overhead travelling cranes, STAHL CraneSystems offers crane builders worldwide the possibility to complete orders effectively and economically with manageable planning outlay. This includes support from our engineering team if wanted. Customer advisory services, planning, construction of the crane system as well as service and the provision of spare parts stay in the hands of the crane builders locally.

STAHL CraneSystems provides the intuitive, structured planning software with continuously updated database. This program grants access to our complete standard programme. Our planning software enables clear, simple configuration of the crane system, time-saving preparation of quotations and trouble-free ordering. With a 2D or 3D visualisation, you can immediately see what your system will look like. You obtain exact details regarding the technology and prices.

STAHL CraneSystems manufactures the hoists, components and other equipment to a high standard of quality and tests the modules for hoisting, travel and control technology exhaustively. The finished CraneKit is delivered preassembled. Assembly of the crane system on site is based on the user-friendly principle of plug-and-play where this is technically possible and meets requirements. And should you ever need help in assembly, the STAHL CraneSystems factory service centre will be glad to help you.

## The facts

---

- Effective and economical
- Intuitive, structured software
- Up-to-date database
- Optional support by engineering team or factory service centre
- Optionally available in explosion-proof design according to ATEX or IECEx

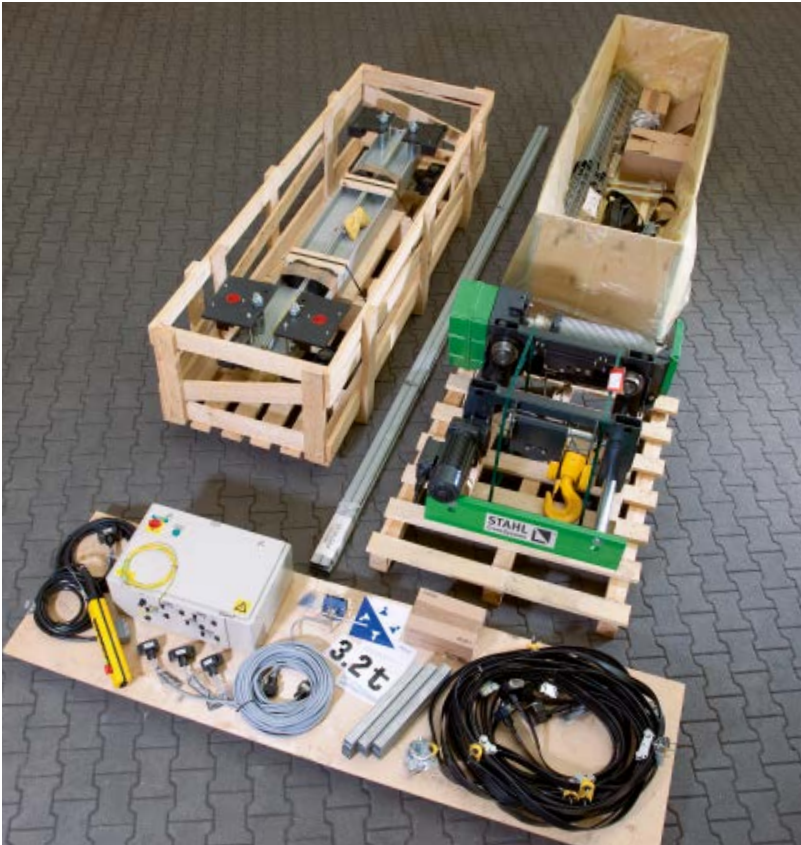

# The crane models

The safe working load range in which suspension cranes as well as single and double girder overhead travelling cranes with crane technology from STAHL Crane-Systems are used extends from 125 kg to 160,000 kg with standard spans of up to 40 m.

The most widespread models – single girder suspension cranes as well as single and double girder overhead travelling cranes – are characterised by low headrooms and short side approach dimensions of the hoists and trolleys. The welded DIN box girders are maintenance-friendly and robust with low power to weight ratio.

From simple workplace solutions, inter-hall systems to complex automation, everything is possible depending on your requirements and conceptions. Various custom versions are available for use under exceptional conditions. For example, cranes with extreme spans, tandem operation, with one or two hoists, with crane collision or obstacle avoidance circuit, in combinations or for outdoor use in all kinds of weather – none of these are a problem. Our crane technology stands out for offering the right solution for every field.

Competent crane manufacturers and system builders around the world will stand by your side in collaboration with STAHL CraneSystems to design, manufacture and commission individual solutions for your needs.

## The facts

- Special installation variants for maximum use of space
  - Custom solutions through engineering
  - Worldwide network of certified partners, crane manufacturers and system builders
- In our engineering department engineers and technicians develop individual custom and off-standard solutions tailored to your specific requirements from one of the largest portfolios of standard components available. They naturally conform to the latest national and international directives and laws.
- You can find a list of certified partners of STAHL CraneSystems as well as crane and system builders near you at [www.stahlcranes.com](http://www.stahlcranes.com).



### The single girder suspension crane

The single girder suspension crane requires very little space and runs on the bottom flange of the crane runway, which is mounted on roof beams or directly on the ceiling. The complete width of the hall is thus available. The distance between the load hook and side walls is extremely small in this case. With this type of crane it is possible to connect various suspension cranes with the help of a crane interlock to enable them to pass hoists with or without loads. In this way it is possible to reach any and every point in a combined system.

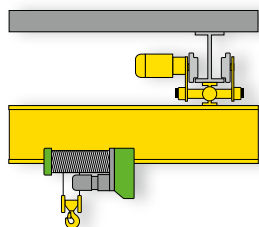

Version »EH-A«

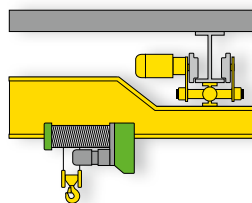

Version »EH-B«

### The single girder overhead travelling crane

The crane bridge girders are adapted individually to the ceiling construction with different connection variants. This allows optimum utilisation of space. The lifting height can be increased further by using a cantilever crab with extremely low headroom or a chain hoist in extra short headroom trolley design.

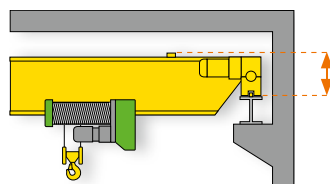

Version »EL-A«

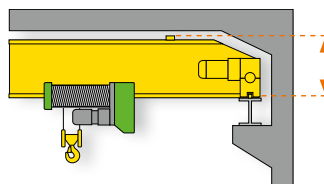

Version »EL-B«

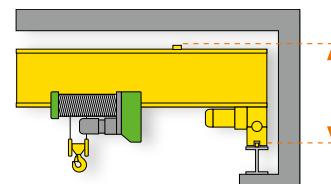

Version »EL-C«

### The double girder overhead travelling crane

The double girder overhead travelling crane allows safe and precise handling of large, bulky loads. It is adapted to planned or existing buildings by means of various special installation alternatives. Numerous additional options are available to increase productivity and safety in day-to-day use.

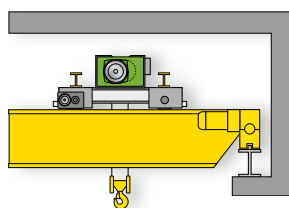

Version »ZL-A«

| Type | S.W.L. to [t]* | Span to [m]* | Hoists  |
|------|----------------|--------------|---|
| EH-A | 10             | 20           | Chain hoist to 6.3t   |
| EH-B | 10             | 20           | Wire rope hoist to 10t                                      |
| EL-A | 16             | 28           | Chain hoist to 6.3t   |
| EL-B | 16             | 28           | Wire rope hoist to 16t                                      |
| EL-C | 10             | 23           |   |
| ZL-A | 160            | 32,5         | SH wire rope hoist,<br>AS 7 wire rope hoist,<br>SHW 8 winch |

\* Higher safe working loads and spans on request

# Quality from a single supplier

## Research & development

STAHL CraneSystems is proud to be a leader in the field of hoists and crane technology. It is the job of our experts to keep rethinking the lifting and conveying of loads and to adapt these tasks to changing industrial innovations. On the way to playing an instrumental role at all times, our experienced engineers and practice-orientated specialists use their sound know-how to advance our technology further. Always with the benefits for our customers and modern technology, high performance and durability in mind.

## The facts

---

- 140 years of know-how and experience
- 140 years with the benefits for our customers in mind





## Production

From carefully selected raw materials and precision manufacture of components to high-quality final product: every product from STAHL CraneSystems stands out for its uncompromising quality, high reliability and maximum performance. The precisely matched individual components are manufactured in our own production plants using the latest manufacturing methods, with demanding work steps being performed by hand. Experienced personnel at our production site in Germany assemble the complete hoists and all crane components and test them exhaustively. Our integrated quality management system meets national and international verification requirements.

## The facts

- High quality and reliability thanks to own production
- Production plant in Germany
- Manufacture using the latest technology
- Integrated quality management
- All components tested before delivery



# Support

Quality down to the last detail is the standard STAHL Crane-Systems is committed to. Not only when it comes to crane technology, but also when it comes to support. You will find hoisting and crane technology from STAHL CraneSystems around the world. Developed by engineers and experts, manufactured with the greatest care and in keeping with our renowned and trusted standard of quality. Many companies from around the world and various fields have opted for maximum safety and quality – for products from STAHL CraneSystems.

We rely exclusively on capable and professional crane manufacturer and system builders to distribute our products. From them you can expect optimum support when it comes to your individual crane system with hoisting and crane technology from STAHL Crane-Systems. Consulting and erection of a new system, system-orientated testing and maintenance, modernisation, spare parts supply and training courses. Together with our subsidiaries and partners, we offer you perfectly coordinated support all over the world.

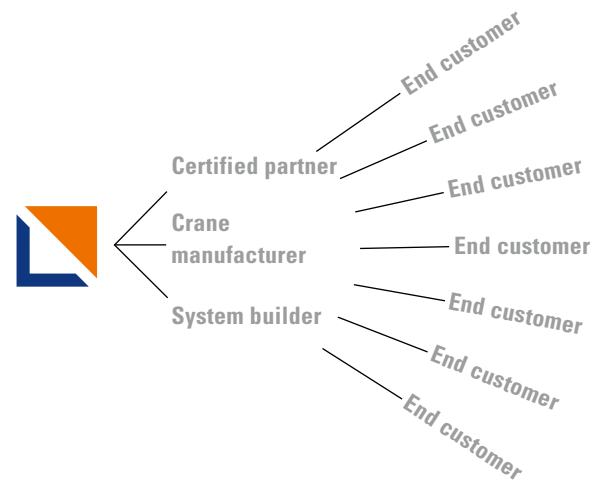



### **Spare parts – available around the clock**

Our own subsidiaries and numerous partners around the world ensure a reliable supply of spare parts and expert assistance in your area. Even decades after a series has been discontinued, spare parts are available all over the world around the clock.



### **Training courses**

We constantly keep our regional crane manufacturing partners up to date with training courses, seminars and information material. And you too as end customer can profit directly from our expertise. We impart practical and theoretical knowledge in our own training centre or on your premises. The seminars on offer in the form of individual, basic and advanced courses cover all main product groups. However, we would also be pleased to develop a special programme for your individual specifications and requirements.

You can find our current seminar programme at [www.stahlcranes.com/en/support](http://www.stahlcranes.com/en/support)



### **Factory service centre – on duty around the world**

Our factory service centre is a service for our customers: wherever you are, we assist your crane or systems manufacturer and your technicians with our experience and expertise whenever needed. Modern diagnostic apparatus and condition monitoring systems stand by to support professional service and maintenance work. Not only you, but also your system are in safe hands. You can rely on us.

You can reach our factory service centre at [customer.service@stahlcranes.com](mailto:customer.service@stahlcranes.com)



### **MarketingPortal plus – our online support**

At [mplus.stahlcranes.com](http://mplus.stahlcranes.com) you can view or download the most important information quickly and conveniently: brochures, product information, technical documents, illustrations and much more.



# The crane technology in use

Experts everywhere immediately recognise the hoists and crane components from STAHL CraneSystems as they are used worldwide in a multitude of different projects in crane and systems building. Innovative, well-conceived to the last detail and manufactured with the greatest of care, countless specific solutions for interesting challenges and requirements are devised with our know-how and our engineering. In such projects our crane technology demonstrates a flexibility and efficiency well above average. STAHL CraneSystems is represented on all continents by subsidiaries, distributors and crane-building partners.

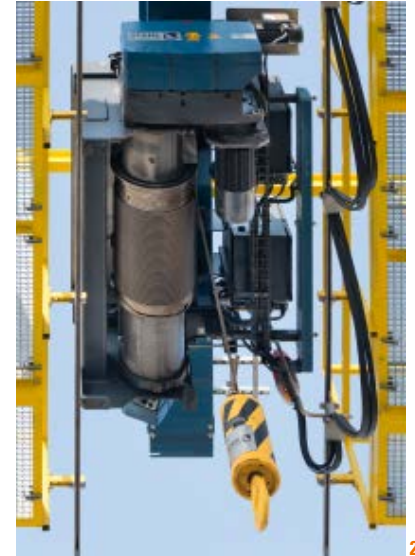

2



1



3



4

1 An explosion-proof ST20 chain hoist with a lifting capacity of up to 1,600 kg is used in a chemical plant for outdoor maintenance work. The narrow construction of the explosion-proof chain hoist allows use of the entire width of the crane bridge. The travel drives of the endcarriages for suspension cranes are also constructed in explosion-proof design.



5

2 LNG wire rope hoists in safety level 1 are used on an LNG terminal in northern China. The customised hoists are based on the SH 6 Ex wire rope hoist and are mounted on a slewing crane on the LNG tank. With a lifting height of 58 metres, they are used for loads up to 3,500 kg in weight. The wire rope hoists were adapted for use on the LNG tank according to Chinese specifications. Robust technology, a corrosion-resistant coating and an enclosure ensure that the maintenance crane is ready for use in the harsh coastal climate at all times. The slewing cranes are equipped on both sides with maintenance bridges.



6

4 A magnet crane lifts variously long steel rods weighing up to 14,000 kg using a two-part lifting beam. When lifting short rods, the two-part lifting beam can be inclined so that only two of the four magnets are used. Additional load measuring bolts enable exact measurement of the weight. The double girder overhead travelling crane is equipped with two SH wire rope hoists with a lifting capacity of 8,000 kg each. To increase the lifting height, the SH wire rope hoists run above the crane bridges. The complete crane control equipment is located on the crane bridge, and operation is effected by radio remote control.

5 Thanks to intelligent crane control, which analyses the load and position data of all cranes, trolleys and hoists in real time and controls the movements of the complete system on the basis of this data, the load of the crane system on the building could be reduced to a minimum.

6 A portal crane with special hoists is used in an independent Dutch research institute. Firstly, an SH 6 Twin Drive Concept wire rope hoist with a safe working load of 12,500 kg and permanent brake, drive and load monitoring. Secondly, an AS 7 wire rope hoist with monorail trolley and a lifting capacity of 12,500 kg. Both wire rope hoists can be linked for tandem operation per remote control. Other interesting features of the high-tech crane are a side crane cantilever arm, a mobile cab, a lifting platform for personnel and energy recuperation.



1

1 A special chain hoist with 12-fold sheaved chain is used for a maintenance crane in the metallurgical plant of a nickel mine. This custom solution, which achieves a safe working load of 30,000 kg, consists of four coupled ST 50 chain hoists. The compact chain hoist is mounted on the double rail crab of a double girder suspension crane.

2 Seven fully automatic, wireless-connected cranes work in the press plant of a car manufacturer. Frequency-controlled SHWF8 winches and frequency-controlled ASF 7 wire rope hoists with lifting capacities of 16,000 kg to 60,000 kg are used. The hoists are equipped for extra high speeds and work with tool grippers.

3 There is only one engine maintenance plant in Europe for the Rolls-Royce engine type Trent, which is used in the Airbus models A 330, A 340 and A 380. It is one of the most modern and advanced maintenance operations worldwide and uses the highly efficient ›vertical strip‹ method. STAHL CraneSystems wire rope hoists in the series SHF 3 to SHF 6 are used here. The hoists work without lateral hook movement and extremely low load swing for precise positioning of the load.

5 Two radio remote controlled single girder overhead travelling cranes with a lifting capacity of 6,300 kg each work in a joinery for solid wood buildings in Bavaria. They are responsible for all transportation from the untreated timber beams to the finished wood walls, which are then loaded on to HGVs.

6 A new crane at a haulage company was retrofitted to lift loads of up to 100,000 kg. Since the existing crane runway was only designed for loads up to 25,000 kg, a special crane control with safety spacing in performance level PL d is used. Multiple redundant systems are used to monitor the crane, e.g. the SMC multicontroller and two high-precision distance lasers for permanent monitoring of the distance. The compact AS 7 twin hoist is used for lifting.

7 A grab crane works in a hot, dusty cooling hall for cast steel moulds for safe and quick picking up and loading of the steel cylinders. Two robust frequency-controlled ASF7 wire rope hoists with individually fabricated rope drums are mounted on a double rail crab. The low-stress and low-wear hoisting movements are carried out thanks to intelligent rope reeving, which keeps the gripper free of vibration, stable and vertically under the hoists when moving with load.



2







1 A Chinese machine builder uses double girder overhead travelling cranes with AS 7 wire rope hoists in its production plant. Many of the cranes work with two hoists – the larger wire rope hoist as main hoist, and the quicker, smaller wire rope hoist as auxiliary hoist.

2 Two frequency-controlled AS 7 wire rope hoists in twin implementation are used to transport coils in a production plant. Space in the 65 m long hall is tight as there is a large production machine in the middle. This area of the hall must be bypassed in normal operation.

3 A series of ST chain hoists are used in England for maintenance and replacement of railway tracks. All hoists are equipped with special load handling equipment. So that the chain hoists work synchronously, they are controlled centrally. Gear-type limit switches see to cut-off, and the lifting procedure is restricted reliably.

4 A single girder suspension crane with 3 endcarriages is used in a hanger in the USA to help in the assembly of the tail parts of the Airbus A380 and Boeing 747. The ST chain hoist with a safe working load of 1,000 kg used is mounted on a cantilever arm of the travel carriage with 800 mm feed. The cantilever arm can be rotated in an angle of 180°. With this auxiliary movement, the crane is able to move the elements of the rudder sideways without using the trolley of the crane.

5 A special stacker crane is used in a company in Bavaria in the semi-automatic production of pre-cast concrete parts. The crane is equipped with a lift mast. It lifts the concrete components, which can weigh up to 5,700 kg, out of the production line and stacks them on transport vehicles.

6 The maximum permissible safe working load of the crane system of 12,500 kg is distributed among four SH 3 wire rope hoists. Every wire rope hoist has a lifting capacity of 3,200 kg. The movements of the cranes, two hoists and pallet gripper are controlled with a radio remote control with joystick.



5



6



1



2

- 1 The double girder overhead travelling crane manufactured in Künzelsau and South Africa has reached the petrochemical plant in Ghana. The system with a total lifting capacity of up to 75,000 kg is equipped with an AS7 wire rope hoist and an SH6 wire rope hoist as auxiliary hoist. For the intercontinental transport, the engineering specialists at STAHL CraneSystems devised an ingenious special construction. For the load test and testing of the SMC and SLE output devices, the big bags had to be filled with water in dry Ghana.
- 2 A double girder overhead travelling crane with an SHW 8 winch with safe working load of 85,000 kg is used in a hydroelectric power plant in Switzerland for maintenance and inspection work on a turbine 40 m below. An SH wire rope hoist with lifting capacity of 10,000 kg and a lifting height of 40 m is used as auxiliary hoist. Thanks to the special controller, the crane can be controlled particularly precisely and finely. The travelling and lifting speeds move in a range of a few millimetres per second.
- 3 A single girder overhead travelling crane with an SH 40 wire rope hoist works in the modern mechanical production plant of a foundry for high-strength castings. The hoist has a safe working load of 4,000 kg and is equipped with heat protection shields.
- 4 A special crane with height-reduced suspended crane end-carriages and an individually adapted custom hoist works in a chemical plant in Germany. The custom hoist is an STD 50 dual chain hoist with two synchronised rope lead-offs. An ST 20 chain hoist serves as an auxiliary hoist.
- 5 Two ST 50 chain hoists at a time lift complete car bodies and transport them through the assembly line.
- 6 A portal crane with a lifting capacity of 50,000 kg is used for maintenance work at a sluice. The AS7 wire rope hoist is located under a protective cover and the travel carriage is easy to reach via a maintenance bridge. This portal crane can be dismantled completely, transported by ship and assembled again. Even after several months of storage, it can be assembled ready-for-use within 48 hours.
- 7 The crane operator operates this crane system above a paper machine via radio remote control. The heavy reel of paper needs to be turned so that it can be placed in the holders of the machine. To this end, it is lifted by two SH 6 wire rope hoists with independent load hooks. They can be set on the right hook spacing on the jointly used rail using an electric drive.



3



5



4



6



7



Argentina Australia Austria Belgium Brazil Canada Chile **China** Columbia Croatia Czech Republic  
Denmark Ecuador Egypt Estonia Finland **France** Germany **Great Britain** Greece Hongkong Hungary **India** Indonesia

Ireland Israel Italy Jordan Latvia Lebanon Lithuania Malaysia Mexico  
Netherlands Nigeria Norway Pakistan Peru Philippines Poland **Portugal** Rumania Russia

**Singapore** Slovakia Slovenia South Africa South Korea **Spain** Sweden Syria  
Taiwan Thailand Turkey **UAE** Uruguay **USA** Venezuela Vietnam

Sales partners **Subsidiaries**

You can find this and other brochures at [www.stahlcranes.com/download](http://www.stahlcranes.com/download). We will gladly also send them to you by post.



Presented by

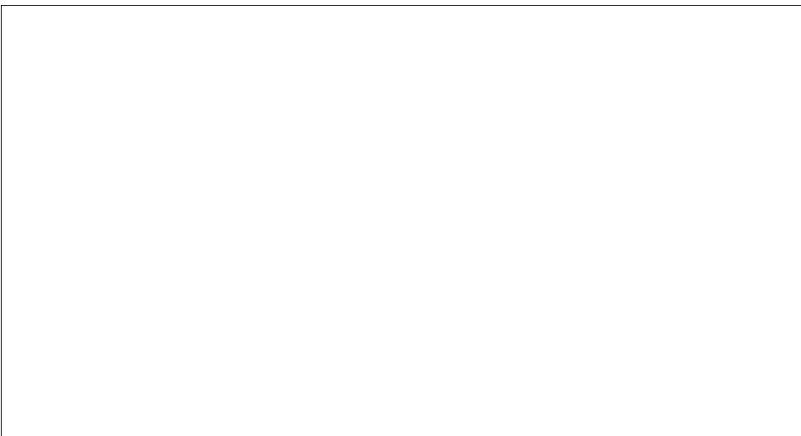

STAHL CraneSystems GmbH  
Daimlerstr. 6, 74653 Künzelsau, Germany  
Tel +49 7940 128-0, Fax +49 7940 55665  
[marketing.scs@stahlcranes.com](mailto:marketing.scs@stahlcranes.com)  
[www.stahlcranes.com](http://www.stahlcranes.com)

a member of COLUMBUS MCKINNON CORPORATION

Partner of Experts



All specifications and illustrations are non-binding.  
Subject to modification, errors and printing errors excepted.  
Printed in Germany 990 076 0 EN-10.19 visuell.de